

Product # _____ Type _____ Date _____

Project Name _____

Project Location _____ Prepared By _____

Lytescaper™ LSP2

Construction

- Housing is die-cast aluminum, heavy duty, structurally rigid and heat dissipating for longer lumen maintenance life-hours. Housing is finished fine texture metallic gray using polyester powder coat. Other optional finishes are available.
- Lens Door Assembly Minimum 1/8" thick tempered glass lens, thermal and impact resistant, sealed with doorframe and housing using extruded, memory retentive gasket. The doorframe is die-cast aluminum.

Optical System

- Largest selection of optical choices shall be available to fit your applications. Please specify your selection from the ordering guide. Photometric Application Data table is provided additional tool for selecting appropriate optic system suitable to the application.
- Glare Control: Choice of external glare control accessories are available. Please select from the catalog ordering guide.

Mounting

- Adjustable aim and lock type yoke is provided to mount on horizontal or vertical surface depending on application. The yoke is made of steel and finished powder coat to match luminaire finish.

Product Applications

- Landscape lighting
- Building façade/Column light
- Statue/Art painting
- Display spot light
- Sign light
- Flag light
- Building wall washer
- Bridges: Pylon or Stay Cable
- Very cold environment flood light

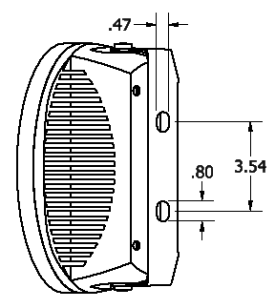
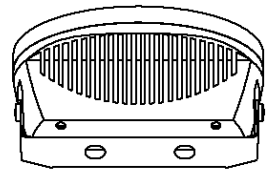
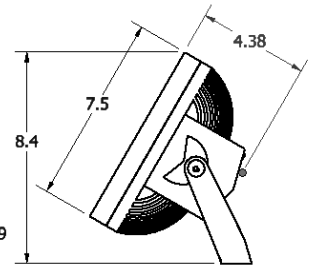
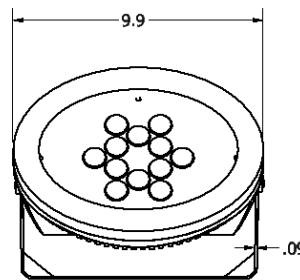
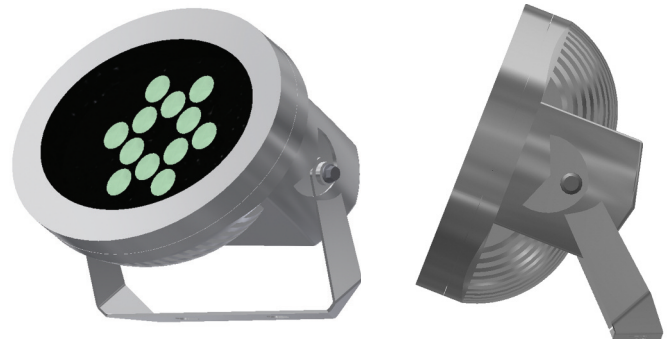

Fixture EPA: 0.6sq. ft.
Weight: 8.0 lbs.

Made in the U.S.A: meets Buy America and ARRA requirements

Ordering Guide

MODEL	TOTAL LED POWER	CCT COLOR TEMP	LIGHT BEAM SPREAD	INPUT VAC	LIGHTING CONTROL	GLARE CONTROL
LSP2	52	CW	N11	U	DM	V
LSP2	25 = 25W	CW = 5K	N11 = 11° Narrow	U = Universal	DM = Dimming 1-10V, Interface only	V = Visor
	38 = 38W	NW = 4K	M26 = 26° Medium	110V to 277V		H = Hood
	52 = 52W	WW = 3K	W46 = 46° Wide			CL = Cross Louver
			ELH = Ellip. Hor.			
			ELV = Ellip. Vert.			
			ASY = Asym. Beam			
			SQR = Square Beam			

Note: North Star Lighting reserves the right to Modify Specifications without notice.

Electrical Components

- AlphaLED™ Light Engine: LED Module is configured with Cree XPG-2 LEDs. The light engine is mounted directly on the highly conductive aluminum die-cast housing. These LEDs are operating below 85°C case temperature and deliver superior maintained illumination per LM80 L70 standards. Please refer LED Performance Data table for the targeted LED illumination life at 25°C to 40° C luminaire outside ambient temperature. The choice of color temperatures (3000K, 4000K and 5000K) are available to match your intended application.
- LED Drivers: UL/CSA recognized component to meet UL8750 & EN61347 (USR/CNR -E328335). Suitable for input power at 120-277VAC 50/60Hz.
- Power connection: A 6 foot long outdoor rated water resistant cable shall be provided for the electrical power connections to the nearest junction box (by others).

Mounting

- Adjustable aim and lock is provided to mount on horizontal or vertical surface depending on application. The yoke is made of steel and finished powder coat to match luminaire finish.

Safety Compliance

- UL 1598 and CSA C22.2 NO. 250.0 standards. Suitable for indoor/outdoor wet (IP65) or damp location use.

Targeted LED Performance

Luminaire Data @ 25°C

CREE LM80 Projected Life Hours Per IESNA TM21

Model	LED Color Temp	LED Watts	Output Lumens	At 25°C,		At 40°C,	
				Luminaire Ambient L70 (9k) Life	TS-°C	Luminaire Ambient L70 (9k) Life	TS-°C
LSP2	5000	25	2544	Greater than 51,400	Under 85	Greater than 51,400	Below 85
	4000		2088				
	3000		1728				
	5000	35	3564	Greater than 51,400	Under 85	Greater than 51,400	Below 85
	4000		2928				
	3000		2400				
	5000	52	4296	Greater than 51,400	Under 85	Greater than 51,400	Below 85
	4000		3528				
	3000		2904				

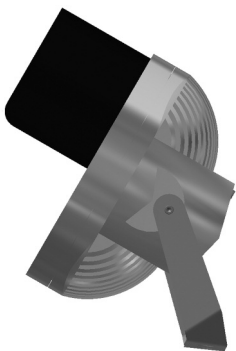

V - Visor

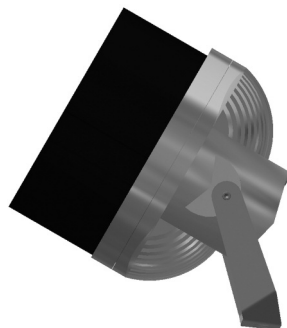

H - Hood

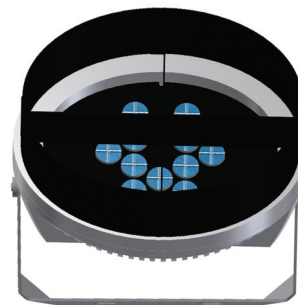

CL - Cross Louver

Photometric Application Data

Performance Values NEMA Classification	Optic N11 1HX1V	Optic M26 3HX3V	Optic W46 4HX4V	Optic ELH 4VX2H	Optic ELV 2HX4V
Maximum Center Candela Cd-max	110464	24528	6905	22815	22815
Maximum Center Fc @ 5 ft Fc5	4419	981	276	913	913
Maximum Center Fc @ 10 ft - Fc10	1105	245	69	228	228
Beam Angle @ 50% of Max. Fc - Ba degrees	8°	20°	44°	37X13	37X13
Field Angle @ 10% of Max Fc - Fa degrees	15°	40°	65°	60X28	28X60
Beam Diameter in feet @ 5 ft - Bd5	0.70	1.76	4.04	3.35X1.14	1.14X3.35
Field Diameter in feet @ 5 ft - Fd5	1.32	3.64	6.37	5.77X2.5	2.5X5.77
Beam Diameter in feet @ 105 ft - Bd10	1.4	3.53	8.08	7.70X2.28	2.28X7.70
Field Diameter in feet @ 10 ft - Fd10	2.63	7.28	12.74	14.54X5.0	5.0X14.54

Photometric Conversion Table

Luminaire Data @ 25°C ambient

To be used to convert from photometry of 52W, 5000K to other wattages and color temperature LEDs

Model	LED Color Temp	LED Watts	Output Lumens	Conversion Multiplier for candela values and foot candle values-all optics options
LSP2	5000	25	2544	0.592
	4000		2088	0.486
	3000		1728	0.402
	5000	35	3564	0.830
	4000		2928	0.682
	3000		2400	0.559
	5000	52	4296	1.000
	4000		3528	0.821
	3000		2904	0.676

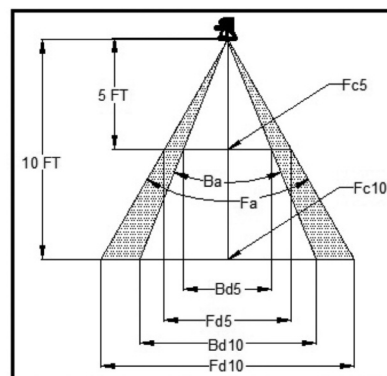

Distance Multipliers

(Adjusted from 10 ft values)

Distance in Feet	Multiplier for Beam or Field	Multiplier for Footcandle values
10	1.00	1.0000
15	1.50	0.4444
20	2.00	0.2500
25	2.50	0.1600
50	5.00	0.0400
75	7.50	0.0178
100	10.00	0.0100
150	15.00	0.0044